



Research Labs

Super Sled-O-Matic
Machine Learning Sleigh Route Finder
QUICK-START GUIDE



SUPER SANTA SECRET:
DO NOT REDISTRIBUTE

1. Introduction

Elf University Research Labs prides itself on creating the most cutting-edge technology for the North Pole, such as the 5 Mega-Jollies Christmas Cheer Laser. And ElfU's brightest scientists have done it again with our prototype Super Sled-O-Matic Sleigh Route Finder. This device replaces the traditional "magical" means by which Santa guides his sleigh every Christmas Eve, in favor of an easy-to-install on-board device powered by Machine Learning - the Super Sled-O-Matic. With the release of the Super Sled-O-Matic, Elf U Research Labs is confident that Santa's sleigh will be even more efficient than ever in carrying out its toy distribution tasks.

This document outlines how the Super Sled-O-Matic device works and how to install it onto Santa's Sleigh.

WARNING! Due to the sensitive nature of this experimental project, this document must be protected by all means. It CANNOT fall into the wrong hands. If it does, the entire holiday season could be ruined. We must guard it with the strictest of security.

2. Features / Specs

The Super Sled-O-Matic includes the following features:

- 2 GHz, Double-core CPU
- 2 GB RAM
- 2 TB SSD Storage
- Mini HDMI and USB On-The-Go ports
- Micro USB power
- HAT-compatible 22-pin header
- Composite video and reset headers
- CSI camera connector
- Satellite Trans-receiver for Global Internet Access
- SRF – Sleigh Route Finder Web API
- Water/Weather-Proof
- Machine Learning Via TinselFlow

2.1 SRF - Sleigh Route Finder Web API

The Sleigh Route Finder (SRF) is the logic module built into the Super Sled-O-Matic device which computes Sleigh Routes using Machine Learning. The SRF has a Web API service on-board to ingest weather data from reporting elf weather stations around the globe. This weather data is then stored on the Super Sled-O-Matic's 2TB SSD.

2.2 Machine Learning Via TinselFlow

TinselFlow is an end-to-end closed source Machine Learning platform created by Elf University Research Labs. TinselFlow includes a closed source library for the most common programming

SUPER SANTA SECRET:

DO NOT REDISTRIBUTE

languages like Python and JavaScript to help Elf U students and North Pole employees to develop and train Machine Learning models.

The Super Sled-O-Matic's SRF logic module utilizes TinseltFlow libraries to train models using available weather data to calculate the best route possible for Santa's Sleigh to deliver millions of presents globally in one night.

3. SRF - Sleigh Route Finder Web API

The SRF Web API is started up on Super Sled-O-Matic device bootup and by default binds to 0.0.0.0:1225:

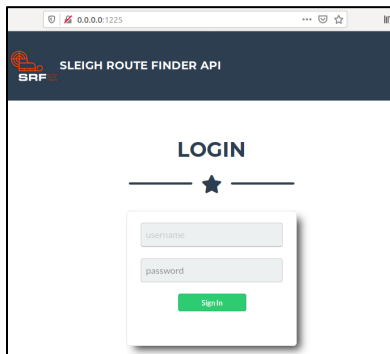

The default login credentials should be changed on startup and can be found in the readme in the ElfU Research Labs git repository.

The Sleigh Route Finder has a weather map showing Elf weather stations around the globe reporting their local conditions. The website also contains a simple IP Firewall for filtering out improper weather traffic from being ingested. These two features can be seen below:

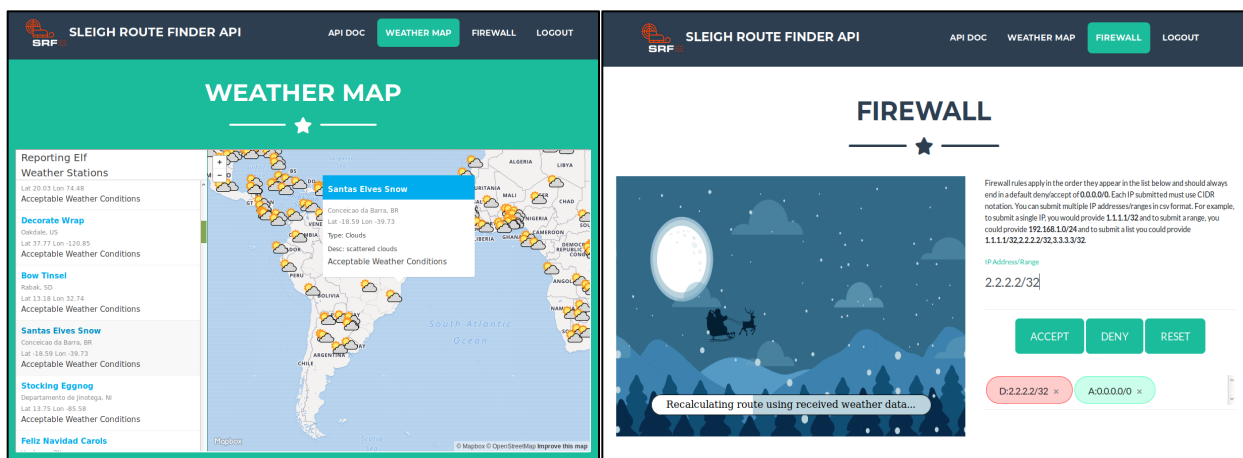

SUPER SANTA SECRET:
DO NOT REDISTRIBUTE

Elf weather stations can report/retrieve weather data using the API which is outlined in the API documentation found on the website:



4. Determine Device Mounting Location

Precautions and Guidelines

As you prepare to install the Super Sled-O-Matic, be sure to take heed of the following precautions:

- 🌀 Turn off power to Santa's Sleigh.
- 🌀 Disable the backup battery power on the Super Sled-O-Matic.
- 🌀 Read thoroughly all installation instructions at least once before beginning.

Proper Mounting Locations

The proper mounting location for the Super Sled-O-Matic is shown in the figure below:

SUPER SANTA SECRET:
DO NOT REDISTRIBUTE

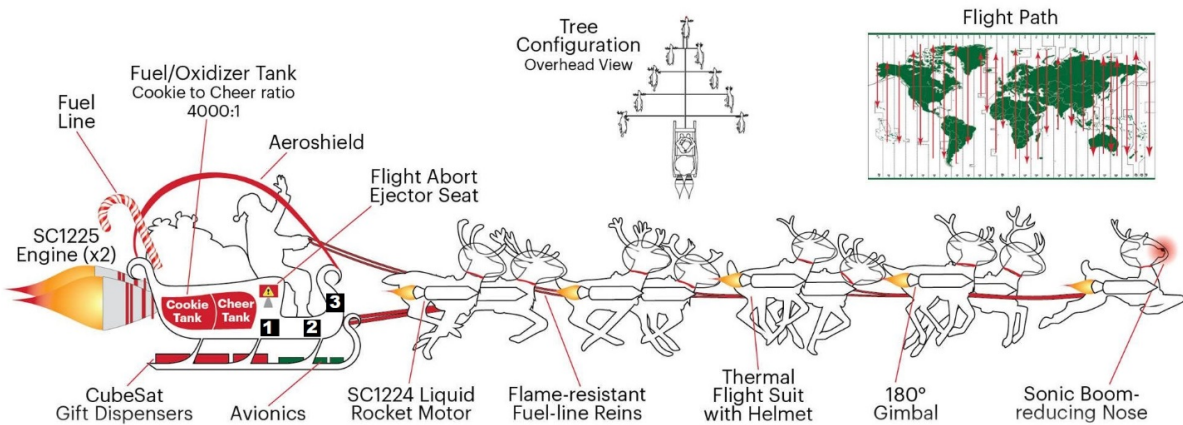

- 1** Right side of sled under the flight abort ejector seat.
- 2** Right side of sled under foot step.
- 3** Anywhere in front of sled.

5. Mounting the Super Sled-O-Matic Device

The bracket allows one to mount the device to Santa's Sleigh -- Be sure that the **white label is facing outward**.



The bracket must be screwed to the Sleigh with the screw provided in the package through the two holes illustrated in the image above.

The side of the Super Sled-O-Matic with the connector should be mounted in the same direction as the L shaped edge illustrated above.

SUPER SANTA SECRET:

DO NOT REDISTRIBUTE

Carefully spread both sides of the bracket to release and remove the Super Sled-O-Matic.

6. Super Sled-O-Matic Wiring Diagram

The Super Sled-O-Matic should be wired according to the figure below.

WARNING: Failure to wire the device properly could result in fire, a sleigh crash, or worse! Proceed with caution!

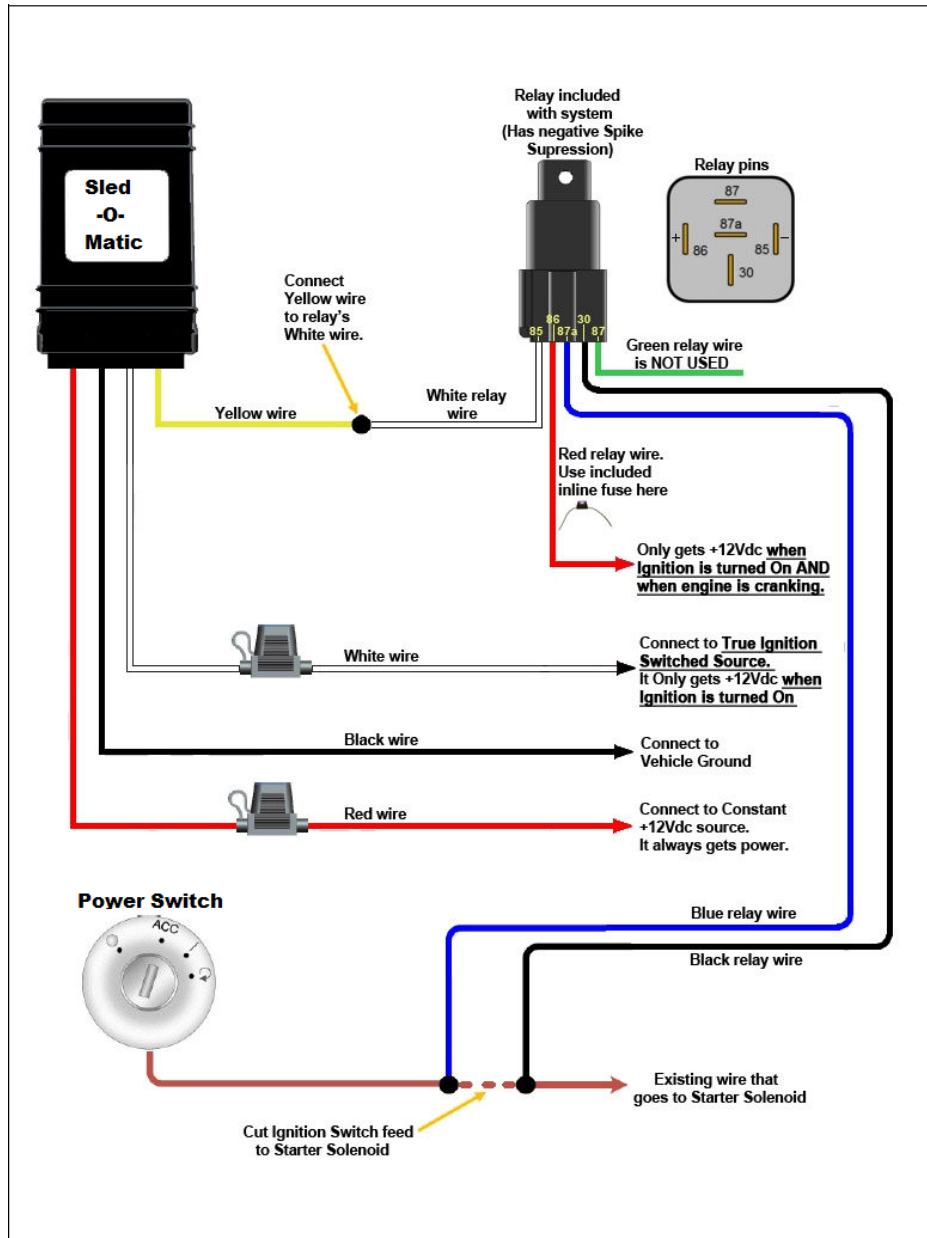



SUPER SANTA SECRET:
DO NOT REDISTRIBUTE

7. Powering on the Super Sled-O-Matic

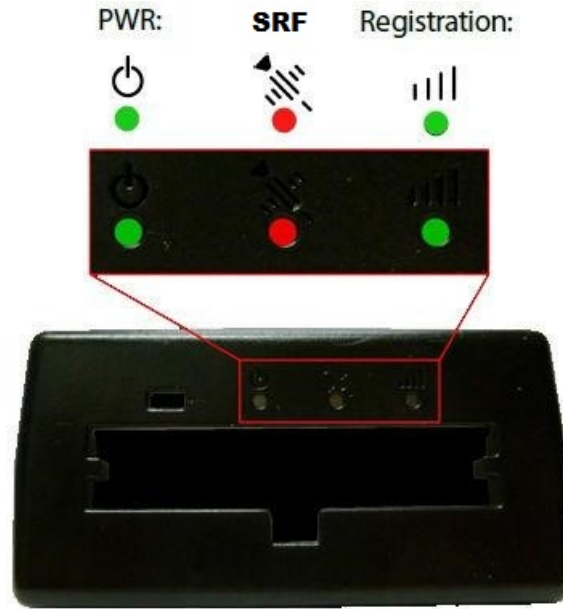
The Super Sled-O-Matic has LEDs that it uses to indicate device status for different features. A Green LED indicates proper functioning and a Red LED indicates that the feature is currently not operational. The large activation button on top of the device must be held down for 10 seconds to turn the Super Sled-O-Matic On.



The LEDs are described in this table:

<p>PWR:</p> 	<p>This LED indicates that the device is either powered on or off. Please allow up to 5 seconds after holding down the Super Sled-O-Matic activation button for the LED to turn from RED to GREEN.</p>
<p>SRF:</p> 	<p>The Sleigh Route Finder built into the Super Sled-O-Matic will display a GREEN LED if it has a Valid Route calculated via Machine Learning. A RED LED indicates that the data is erroneous or weather conditions are too severe.</p>
<p>Registration:</p> 	<p>This LED indicates the internet connection status of the Satellite Transceiver. A solid green LED indicates that internet status is solid. A blinking green LED indicates internet connection is working but intermittent. A red LED indicates no internet connection.</p> <p>After three hours of non-use, the device attempts to power-down.</p>

SUPER SANTA SECRET:
DO NOT REDISTRIBUTE

8. Powering on the Super Sled-O-Matic Backup Battery

The following figure shows the activation button used to turn on the battery backup for the Super Sled-O-Matic

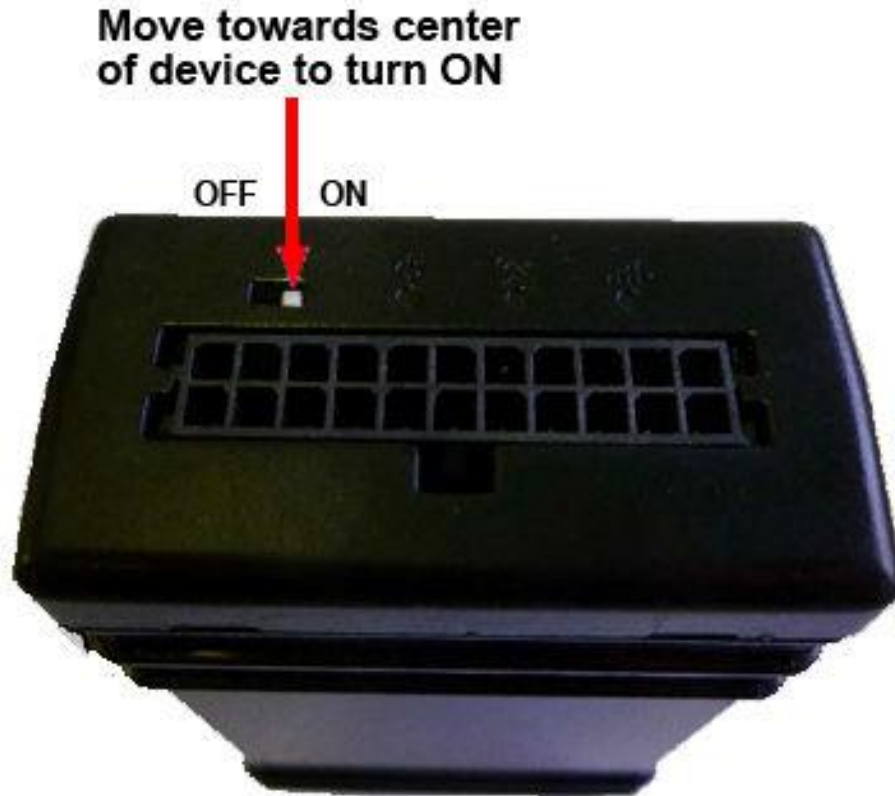

SUPER SANTA SECRET:
DO NOT REDISTRIBUTE